



GLASS SYSTEMS

PALMIYE

MADE FOR OUTDOOR LIFE



1 MANIFESTO

8 GLASS SYSTEMS

8 Folding Glass Systems

10 Double Glass Folding System

14 Sliding Glass Systems

18 Sliding S

22 Double Glass Sliding System

24 Lift and Slide System

26 Fixed Glass Systems

30 Rectangular Fixed System

32 Triangular Fixed System

34 Parapet Systems

38 Fixed Parapet System

40 Adjustable Parapet System

46 Door Systems & Accessories

50 Glass Door

52 Aluminum Door

54 Photocell Door

56 Accessories



**MADE FOR
OUTDOOR LIFE**



At Palmiye, we believe in enhancing people's lives through innovative outdoor solutions, making daily life easier and better. For over 25 years, we have been building innovative systems which are at the crossroads of art and science. Engineering and creativity. Global knowledge and client focus. Craft, quality, freedom of choice, and custom-made solutions that are sustainable. We do this in ways that endure and stand the test of time. Reflecting our commitment to creating a lifestyle

Made For Outdoor Life.

GLASS SYSTEMS

MODELS

**Folding Glass Systems
Sliding Glass Systems
Fixed Glass Systems
Parapet Systems
Door Systems & Accessories**

Year-Round Comfort with **GLASS ENCLOSURE SYSTEMS**

Experience the ultimate in outdoor living by adding our glass enclosure systems to your pergola or any outdoor space. Say goodbye to seasonal limitations and embrace a new level of comfort and luxury in your outdoor space. Discover the possibilities today and create a living space that knows no boundaries.



Tailored Glass Enclosures for **YOUR UNIQUE SPACE**

Our extensive range of glass enclosure systems ensures a perfect match for any space.

Whether you have a cozy backyard pergola or a chic urban rooftop retreat, our tailored solutions cater to your unique requirements.

Choose the ideal glass system to seamlessly integrate with your space and enjoy indoor-outdoor living in your own distinctive style

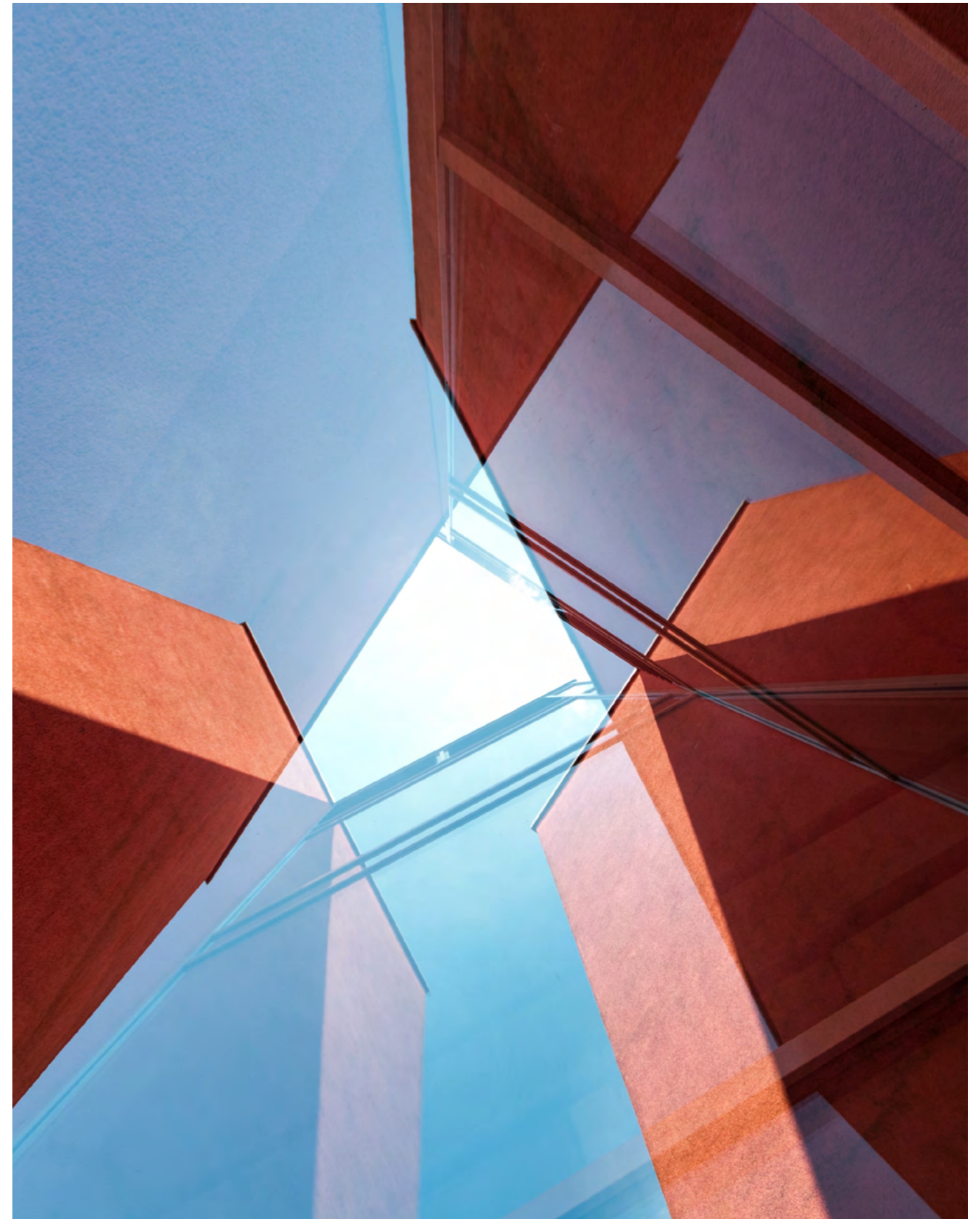

**YOUR PATH TO YEAR-ROUND
OUTDOOR BLISS**



FOLDING GLASS SYSTEMS

DOUBLE GLASS FOLDING SYSTEM

This protective and classy concept has been developed in order to provide maximum comfort to any living space.



ROBUST AND DRY SPACES

With perfect water and heat insulation as well as being completely airtight it integrates indoor and outdoor living.

The strength of this system enables it to carry heavy panels and the extra rubber surround makes the system completely air tight and waterproof.



EASY OPERATION AND DURABLE DESIGN.

Small wheels along the top and bottom of the frame enables the panel to open and close in the accordion folding style.

Each panel is enclosed with an aluminium frame and in turn connected to each other with strong hinges.

TECHNICAL FEATURES

DIMENSIONS

Max Height	260 cm
Max Width	600 cm
Max Wing Width	100 cm
Min Wing Width	60 cm

GLASS OPTIONS

Glass 4+16+4 mm
Insulated Tempered

GLASS COLOR OPTIONS

Transparent
Blue
Green
Smoked

STANDARD CONFIGURATIONS

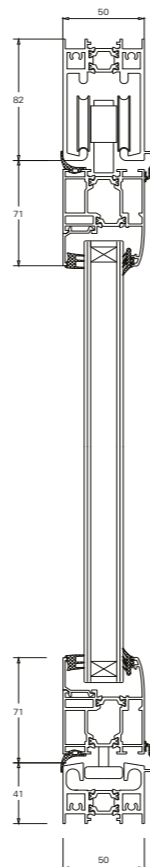



SLIDING GLASS SYSTEM

**Sliding S
Double Glass Sliding System
Lift & Slide System**

Seamless Elegance: **SLIDING GLASS SYSTEMS**

Palmiye's sliding glass systems provide the perfect blend of style and functionality for your living space. Effortlessly open up your room to the outdoors while maintaining energy efficiency and weather resistance.

Experience the ultimate in modern design and convenience with sliding glass systems.



SLIDING S

Palmiye's sliding glass system is perfect for any building and pergola, its adjustable wheels ensure smooth manoeuvring of each panel to both left and right.

Sliding Glass System S provides wider openings with 3, 4, 5, 6 rail options.



Palmiye's Sliding Glass System S:
VERSATILE AND SMOOTH.

CLEAN AND SPACE-EFFICIENT

The tiny brushes between the 10 mm glass prevents dust entering. Whether open or closed there is no loss of space with this system.

STYLISH COMFORT, PROTECTING YOUR SPACE!

This protective and classy concept has been developed in order to provide maximum comfort to any living space.



TECHNICAL FEATURES

DIMENSIONS

Max Height	300 cm
Min. / Max Wing Width	50 / 150 cm
Glass	10 mm Tempered
Glass Color	Transparent
First Panel	Standart Circle Handle

GLASS OPTIONS

10 mm Tempered

GLASS COLOR OPTIONS

Transparent

Blue

Green

Smoked

PANEL CONFIGURATION

3 Railed Sliding System S

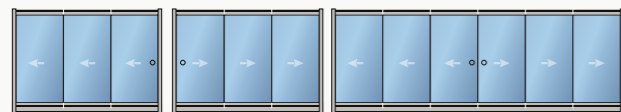

3 Panel Left 3 Panel Right 3 Panel Left & 3 Panel Left

5 Railed Sliding System S

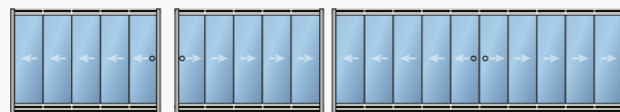

5 Panel Left 5 Panel Right 5 Panel Left & 5 Panel Left

4 Railed Sliding System S

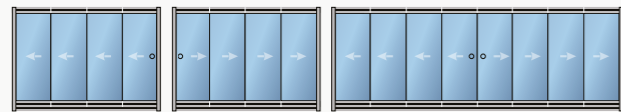

4 Panel Left 4 Panel Right 4 Panel Left & 4 Panel Left

6 Railed Sliding System S

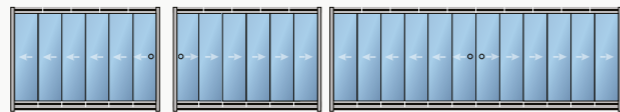

6 Panel Left 6 Panel Right 6 Panel Left & 6 Panel Left

BOTTOM PROFILE OPTIONS

Choose from three ground connection options: Standard, With ramped profile, or embedded in the floor, to suit your specific requirements. Elevate your living or commercial space with endless design possibilities.

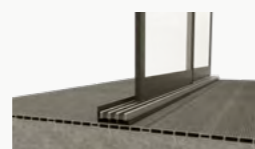

Standard



With Ramp Profile

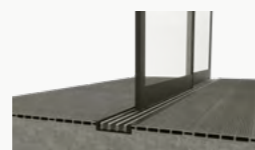

Embedded in the floor with F profile

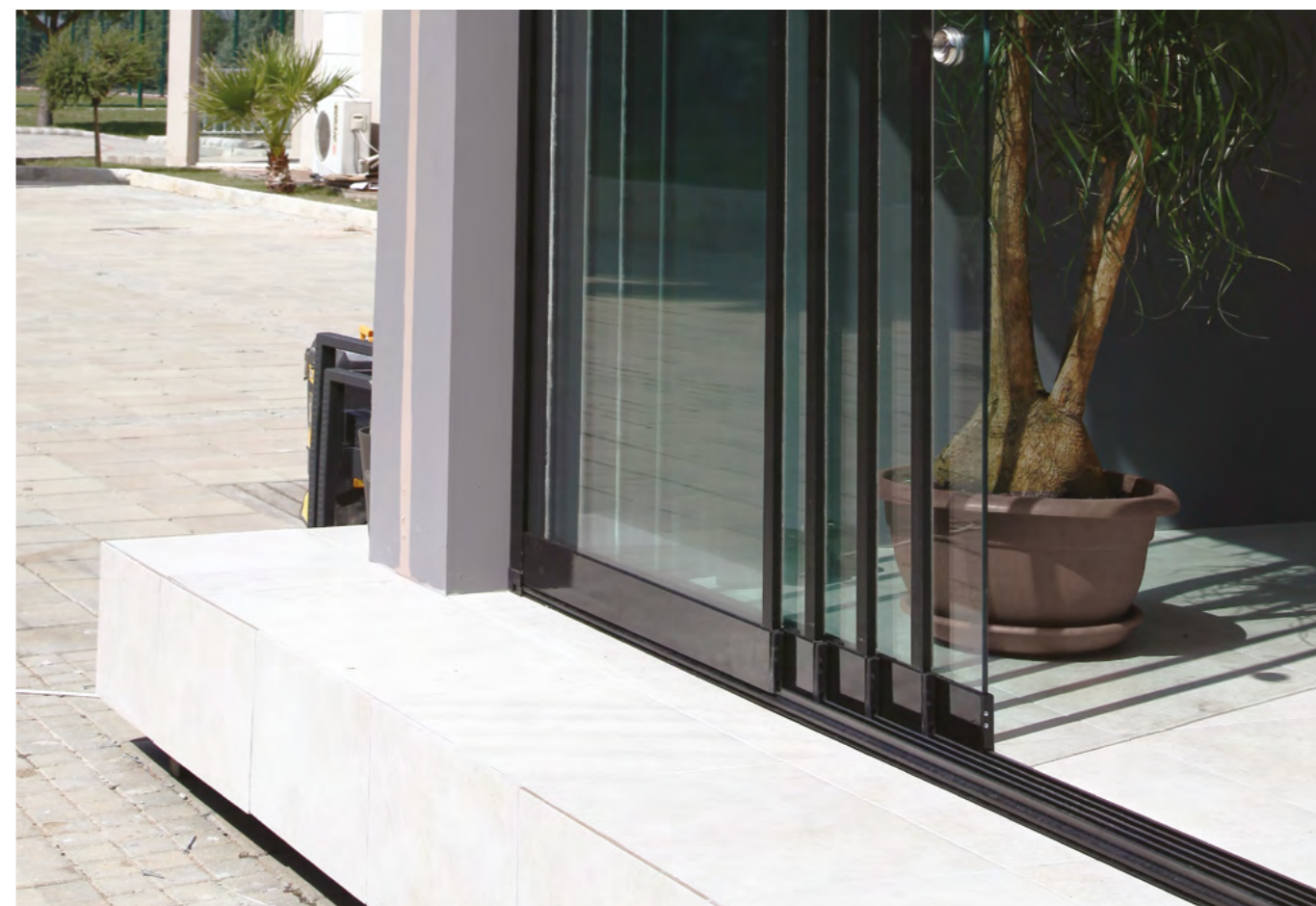
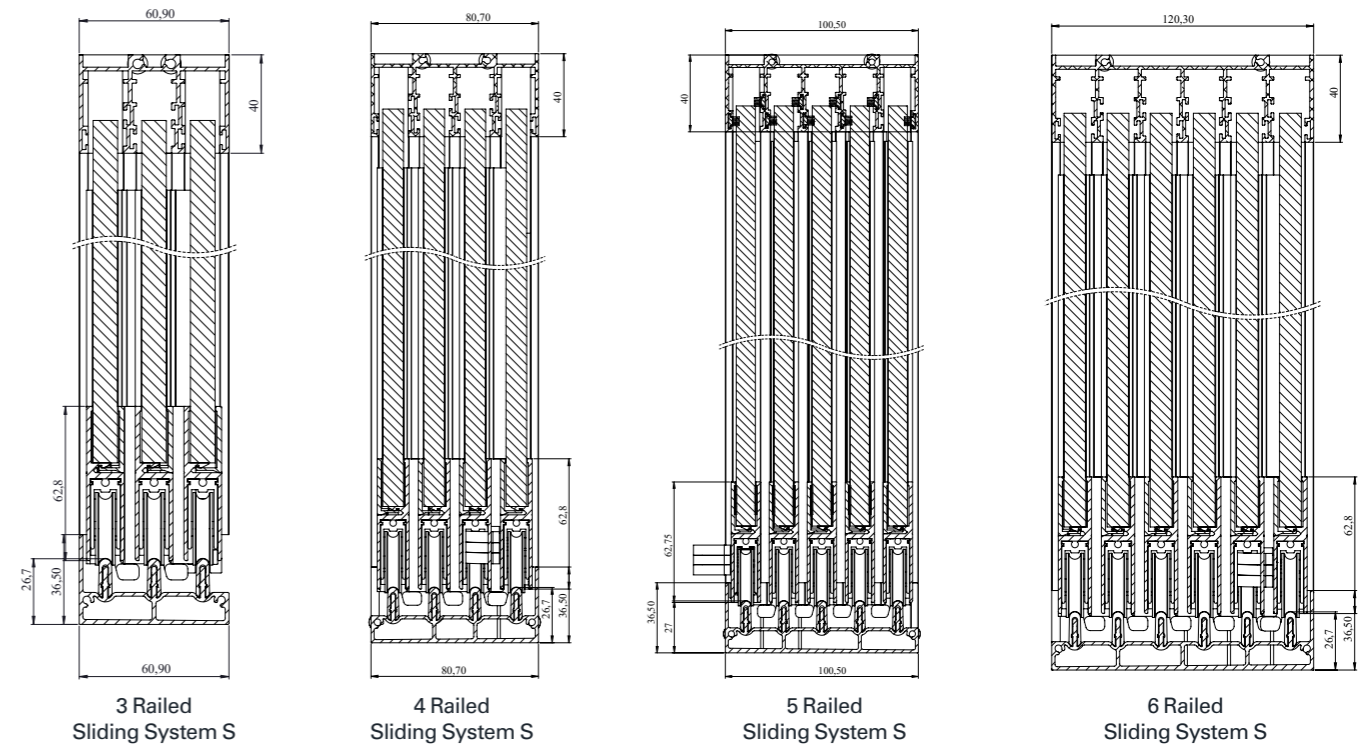

DOUBLE GLASS SLIDING

FOR BETTER INSULATION!

Buildings where insulation solutions have been prioritized, offers great comfort to its users. With this solution you maximise the use of the natural heat that daylight provides.



SMOOTH OPERATION, DUST & WATER PROTECTION

This is an indispensable complement to energy saving efforts. The specially designed wheel system ensures smooth manoeuvring of each panel to both left and right and the tiny brushes between the glass panels prevents dust and water entering.

TECHNICAL FEATURES

DIMENSIONS

Max Height	300 cm
Max Width	600 cm
Max Wing Width	150 cm
Glass	4+12+4 Tempered Insulated
Glass Color	Transparent

GLASS OPTIONS

4+12+4 Tempered Insulated
4+12+4 Tempered Insulated (Coloured)

GLASS COLOR OPTIONS

Transparent
Blue
Green
Smoked

CONFIGURATIONS

Buildings where insulation solutions have been prioritized, offers great comfort to its users. With this solution you maximise the use of the natural heat that daylight provides.

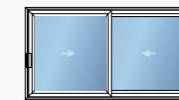

2 SLIDING WINGS

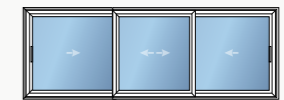

3 SLIDING WINGS

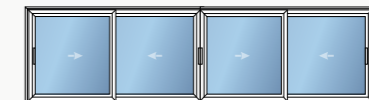

4 SLIDING WINGS

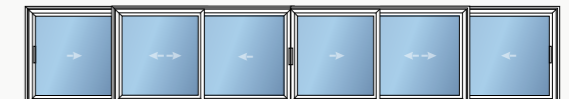

6 SLIDING WINGS

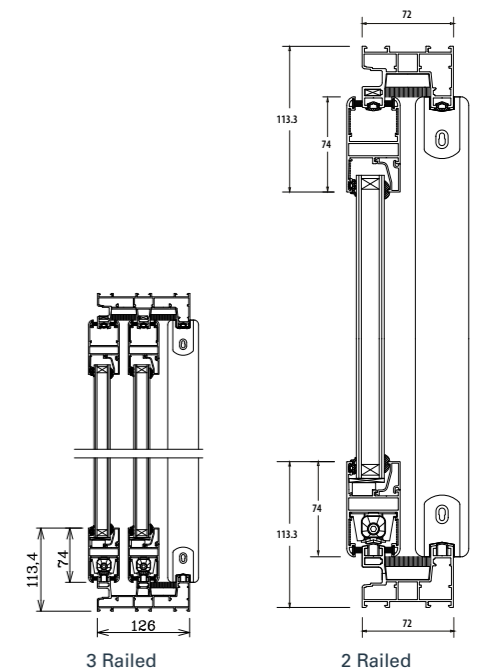

LIFT AND SLIDE SYSTEM

UNCOMPROMISED INSULATION AND BREATHTAKING VIEWS

When closed this system offers perfect water, wind, heat insulation and in addition to this the huge panels enable an unbroken panoramic view.



EFFORTLESS AND LIGHTWEIGHT:

In order that the panels can be so big and the view unbroken, the system consists of a lifting mechanism that first lifts the panel and then slides it. It is a very light weight system and slides very easily and smoothly without much effort.



TECHNICAL FEATURES

DIMENSIONS

Max Height	300 cm
Max Width	600 cm
Max Wing Width	200 cm

GLASS OPTIONS

6+14+4 mm
Tempered Insulated

GLASS COLOR OPTIONS

Transparent
Blue
Green
Smoked

CONFIGURATIONS

When closed this system offers perfect water, wind and heat insulation and in addition to this the huge panels enable an unbroken panoramic view.



2 Sliding Wings



4 Sliding Wings

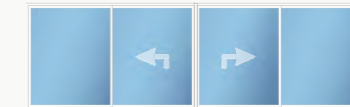

2 Sliding Wings 2 Fixed Wings

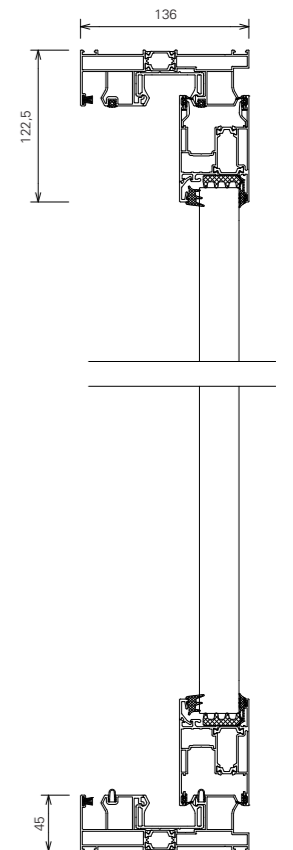



FIXED GLASS SYSTEM

Rectangular Fixed System
Triangular Fixed System

CREATIVE and STYLISH

With numerous options, this way of architecture is a creative and stylish way to split up your area. As well as different colour options, glass films with any text or design can be laminated directly onto the glass.

For Brighter and AIRIER SPACES

Dividing spaces or enclosing areas with Palmiye's fixed glass system creates a lighter and brighter atmosphere



INCLUSIVE LIVING SPACES

Frameless applications divide without excluding and provide a light, stylish and enjoyable area to live in.

RECTANGULAR FIXED SYSTEM

Fixed glass systems provide protection and energy efficiency but also elevate the overall ambiance of your space. Their minimalist, sleek design allows natural light to flood in while safeguarding against the forces of nature.



BEYOND WALLS, EMBRACE NATURE'S GALLERY.

With fixed glass systems, you can enjoy the beauty of the great outdoors from the comfort of your interior space, experiencing the perfect blend of form and function. Make a bold architectural statement and create a lasting impression with fixed glass systems, the epitome of modern design and reliability.

TECHNICAL FEATURES

DIMENSIONS

Max Height	300 cm
Max Wing Width	600 cm
Glass	4+4 mm Laminated
Glass Color	Transparent

GLASS OPTIONS

Tempered
Laminated

GLASS COLOR OPTIONS

Transparent
Blue
Green
Smoked

APPLICATIONS

	4+4 Laminated	5+5 Laminated	6+6 Laminated	Insulated Tempered (4+9+4)
S3000	•	•	•	•
S6000	•	•	•	•

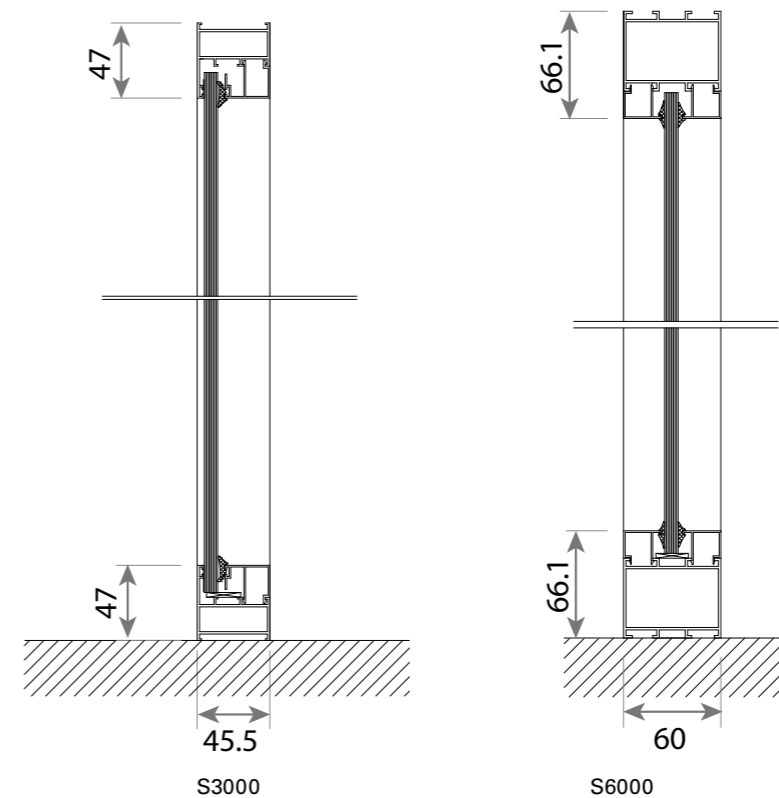

TRIANGULAR FIXED SYSTEM

Elevate your pergola experience to the next level with our innovative fixed glass systems. Now, you can seamlessly enclose the triangular sections on the sides of your pergola, transforming it into a year-round oasis of comfort and style.



TECHNICAL FEATURES

DIMENSIONS

Max Height	230 cm
Max Width	230 cm
Glass	4+4 mm Laminated
Glass Color	Transparent

GLASS OPTIONS

Tempered
Laminated

GLASS COLOR OPTIONS

Transparent
Blue
Green
Smoked

APPLICATIONS

	4+4 Laminated	8 mm Laminated Tempered	Insulated Tempered (4+6+4 mm)
Plus Triangle	•	•	•
Compact Triangle	•	•	-

TRIANGLE

There are 2 types of triangular fixed glass systems compatible with Palmiye's Plus and Compact Pergola series.

Plus Triangle

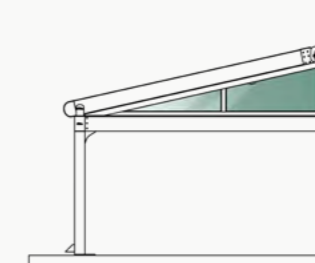

Compact Triangle

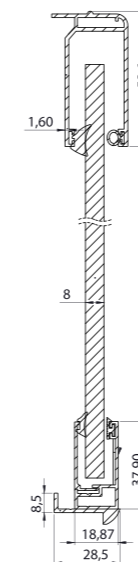
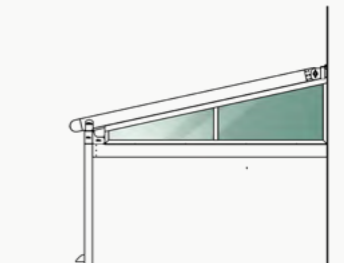

Compact Triangle

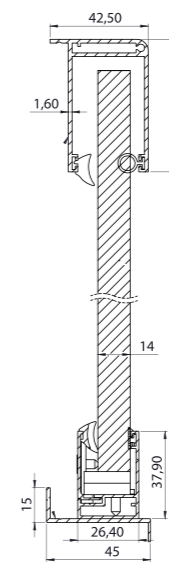

Plus Triangle Insulated Glass

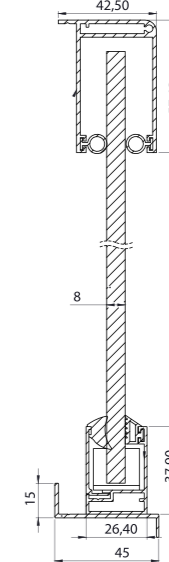

Plus Triangle Single glass



PARAPET SYSTEMS

Fixed Parapet Systems
Adjustable Parapet Systems

Where Safety and **AESTHETICS UNITE**

Parapet systems play a pivotal role in various building projects, providing both essential safety and enhancing architectural aesthetics. Whether applied in commercial properties, residential structures, or public spaces, these systems offer a blend of protection and design refinement.



A View
Without Bounds

FIXED PARAPET SYSTEM

FRAMELESS PANELS AND UNINTERRUPTED VIEW!

With its strong frameless panels the Parapet system provides uninterrupted views as well as a welcome wind shield too.



It is an ingenious form of glass fencing that can either be installed directly into the ground giving the appearance of the glass coming straight up from the earth or into a metal rail that runs along the bottom of the panel of glass.

EMBEDDED OR ABOVE THE GROUND

TECHNICAL FEATURES

DIMENSIONS

Max Height	105 cm
Max Width	-
Glass	6+6 mm Laminated Tempered 8+8 mm Laminated Tempered
Glass Color	Transparent

GLASS COLOR OPTIONS

Transparent
Blue
Green
Smoked

PANEL CONFIGURATION

With its strong frameless panels the Parapet system provides uninterrupted views as well as a welcome wind shield too.

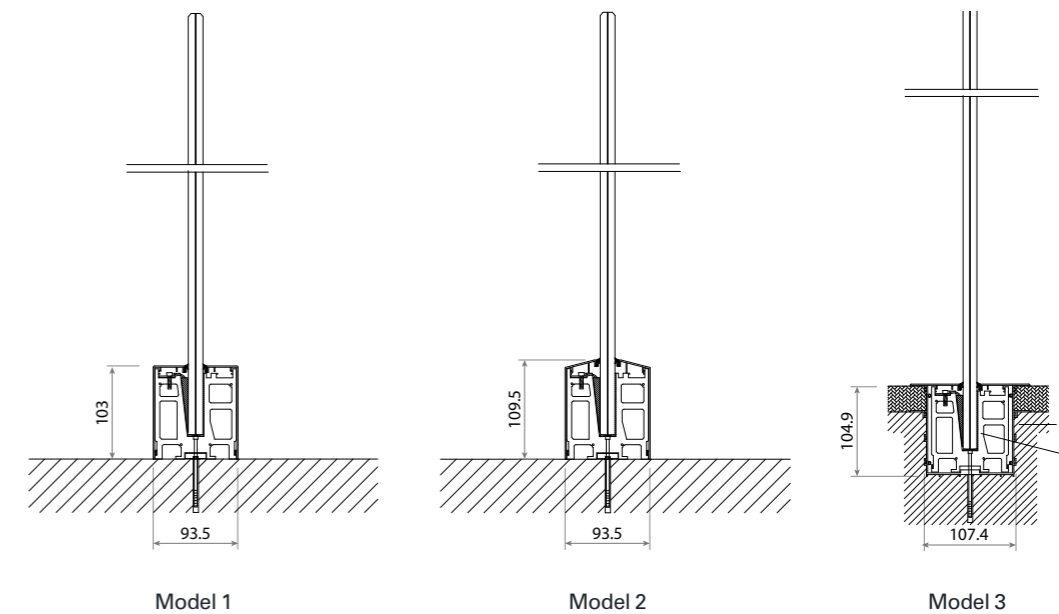
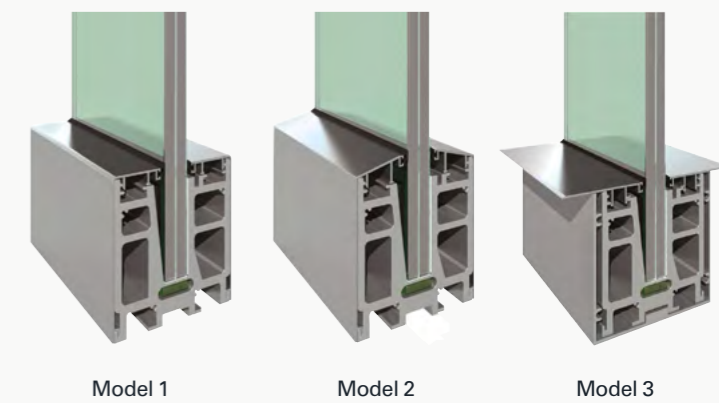

ADJUSTABLE PARAPET SYSTEM

This vertically operating parapet system offers exceptional versatility. What sets it apart is the convenience of remote control, allowing you to adjust its configuration effortlessly to meet your needs.



Vertical Freedom **REMOTE PRECISION**

Whether you wish to create separate interior spaces or enjoy an open balcony with wind protection, the parapet system's remote control operation puts you in control.

TECHNICAL FEATURES

DIMENSIONS

		2 Panels Motorized			
Width	150-400 cm	150-375 cm	150-350 cm	150-325 cm	150-300 cm
Height (max.)	200 cm	225 cm	250 cm	275 cm	300 cm

		3 Panels Motorized			
Width	150-400 cm	150-375 cm	150-350 cm	150-325 cm	150-300 cm
Height (max.)	300cm	325 cm	350 cm	375 cm	400 cm

Maximum Height varies according to width correlation.

GLASS OPTIONS

	3 Panels	2 Panels
Motorized Single Glass	8 mm Tempered	8 mm Tempered
Motorized Double Glass	5+12+5 Tempered	5+12+5 Tempered

GLASS COLOR OPTIONS

- Transparent
- Blue
- Green
- Smoked

CONFIGURATIONS

Operating vertically this parapet system can function interiorly as a room divider, and exteriorly as a balcony and wind breaker.

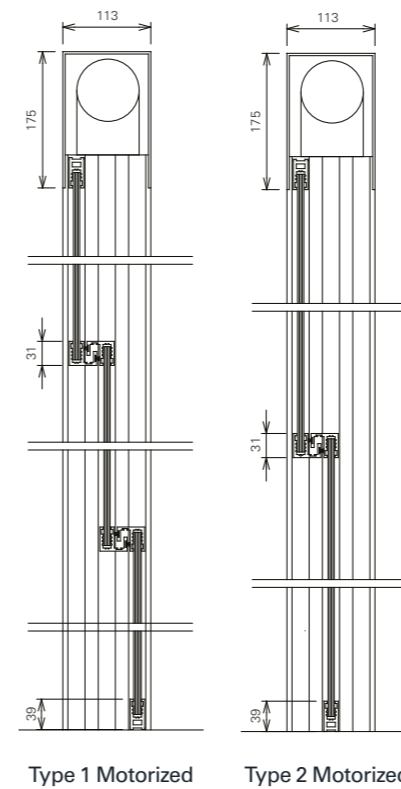
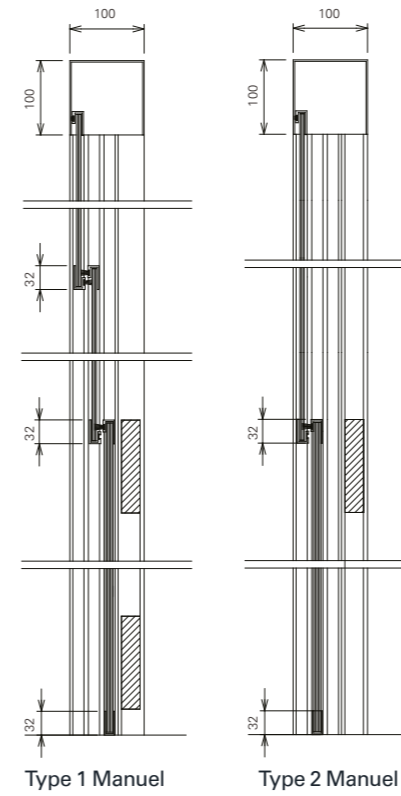
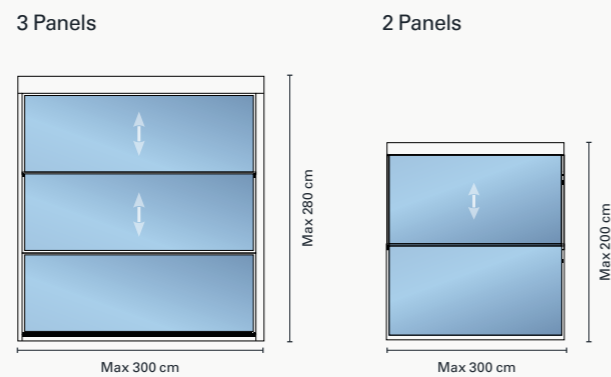

CONTROL & AUTOMATION

Designed to easily control your product wherever you are in the world, despite the weather changes you can remotely activate your products accordingly.

Compatible with iOS and Android smartphone systems. You can assign multiple functions through created scenarios, you can give a one-touch command.



TAILORED TO YOUR LIFESTYLE!

Our products incorporate Somfy motors, remote controls, sensors, and automation systems, giving customers the choice between RTS and IO options.



SITUO 1&5

Elegant design that allows you to easily control your product.

The standard control unit.



TELIS 16

16 Channel ergonomic design that allows you to control all functions at the same time from one control.

The standard control unit.



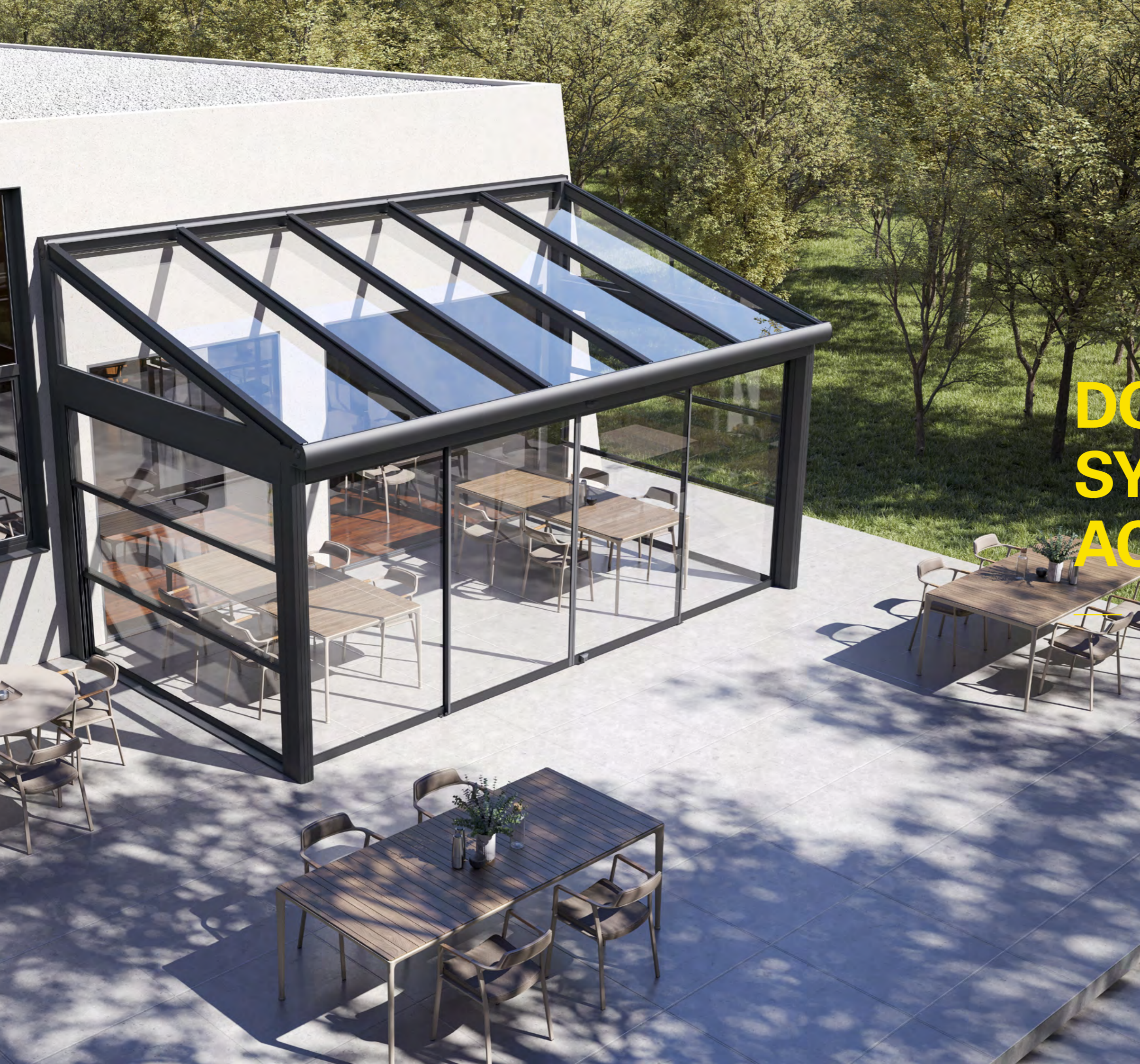

DOOR SYSTEMS & ACCESORIES

Glass Door
Aluminium Door
Photocell Door

FOR SEAMLESS OUTDOOR LIVING

Experience the best of both worlds with our door systems suitable for pergolas or any type of buildings, providing protection from the elements without compromising your connection to the outdoors.



BEYOND DOORS,
INTO OUTDOOR COMFORT

GLASS DOOR

The beautifully designed panoramic glass door is an elegant feature in many buildings, flooding a room with natural light and creating a seamless flow between your various living arrangements.



CUSTOMIZABLE SOLUTIONS

This sturdy, frameless door has a special mechanism to stay fast in either the open or closed position. Different accessories are available to apply directly to the glass door.

TECHNICAL FEATURES

DIMENSIONS

Max Height	300 cm
Max Width	100 cm (One Side)
Glass	10 mm Tempered
Glass Color	Transparent
Handle	Standard Cylinder Handle

GLASS OPTIONS

10 mm Tempered

GLASS COLOR OPTIONS

Transparent

Blue

Green

Smoked

CONFIGURATIONS

Panoramic glass door comes in both single and double models. The single model features a sleek design with high-quality glass panels. The double model, with two aligned glass panels, maintaining the same modern design and optimizing the flow of natural light into your structure.

Single Door



Double Door

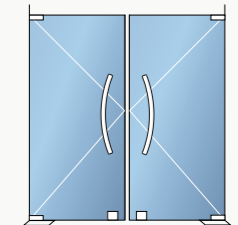

ALUMINIUM DOOR

Palmiye's aluminium door provides a warm, stylish and functional door system. Its robust, yet smooth operation results in a product you can rely on!



With a range of colours available from our powder coating, this Aluminium Door System adds strength and substance to your existing building.

TECHNICAL FEATURES

DIMENSIONS

Max Height	300 cm
Max Width	100 cm (One Side)
Glass	4+9+4 mm (Insulated)
Glass Color	Transparent

GLASS OPTIONS

4+4 mm Laminated
4+9+4 mm Laminated

GLASS COLOR OPTIONS

Transparent
Blue
Green
Smoked

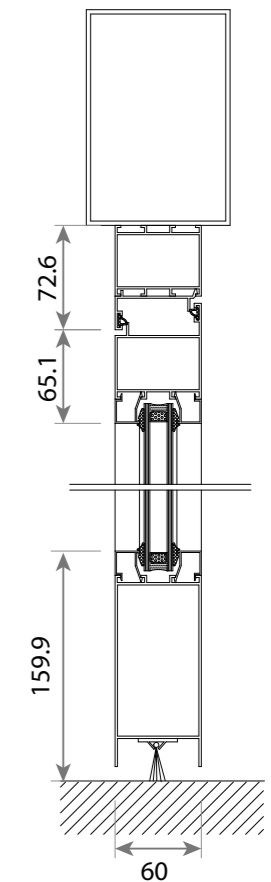

PHOTOCELL DOOR

The stylish door system operates with a photocell sensor for security and access control, while providing excellent weather sealing and maximum visibility with reduced frames.

TECHNICAL FEATURES

DIMENSIONS

Height	200-250 cm	250-300 cm
Max Wings Width	100 cm	85 cm

GLASS OPTIONS

4+4 mm Laminated

GLASS COLOR OPTIONS

Transparent

Blue

Green

Smoked



CONFIGURATIONS

This clean cut and stylish door system operates with a photocell sensor.

Single-Way Slide

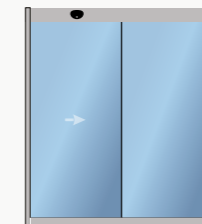

Dual-Way Slide

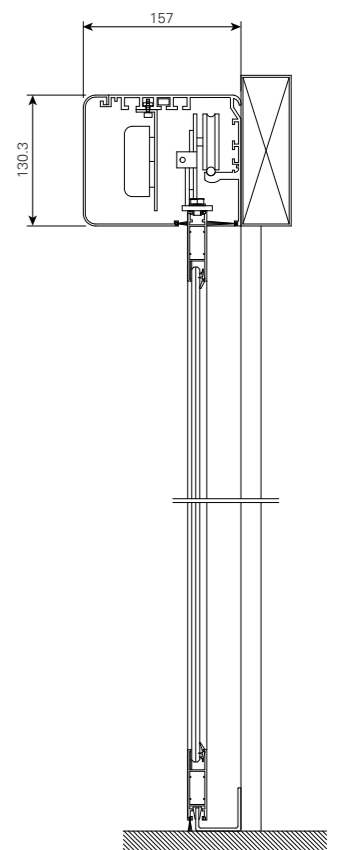
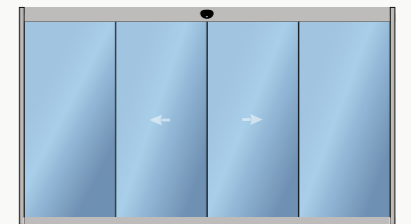

**SENSOR-OPERATED
& STYLISH**

HANDLES

CIRCLE

It's beautiful design complements each individual project beautifully.

- Drill hole in glass: Ø 50mm
- Outer: Ø 60mm



CYLINDER

Both stylish and functional this cylinder door handle is made from stainless steel. Its dual notch design enables it to snuggle perfectly into the hand and it is a preferred option in many projects.

- Drill hole in glass: Ø 10mm
- Outer: Ø 60mm

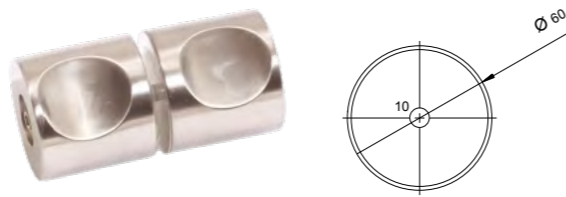

ALLURE

This elegant handle has been designed especially for our aluminium door. It offers smooth operation and aside from its stylish appearance, you are assured each time you grasp the handle that this is a quality set apart from others.

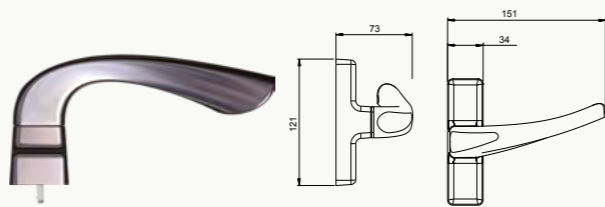

OVAL SERIES

The handle on a door is actually more important than anyone realizes.

- Drill hole in glass: Ø 10mm

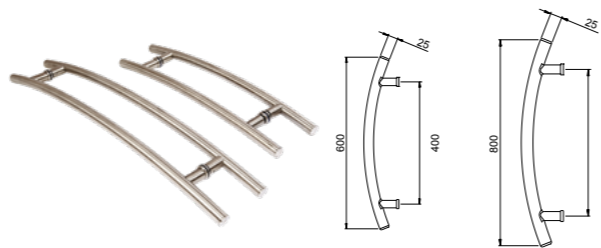

LINEAR SERIES

The stylish Linear Series is a push & pull handle that is screwed directly into the glass door and is available in 4 lengths in stainless steel. With its classic, slim design it fits to any project.

- Drill hole in glass: Ø 10mm

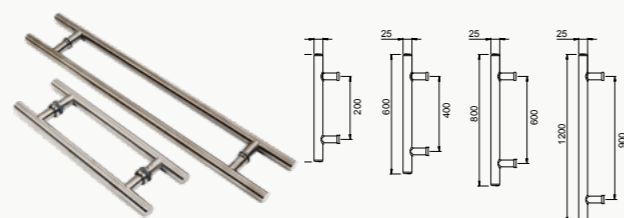

LOCKS

INSULATED SLIDING GLASS LOCK

This Lock is used on insulated sliding glass panels. With its intelligent Lock-in-feature, all metal parts are made from Stainless Steel and are of highest quality to enable smooth operation which makes it a joy to use.



FOLDING GLASS LOCK

This lock is used for all of our folding glass systems. Its combination of advanced technology and design enables easy operation at all times. It is a functional solution to lock the glass panels.

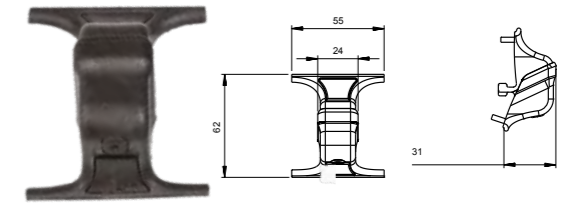

FOLDING GLASS KEY LOCK

A reliable locking system with the added benefit of extremely easy installation, our folding glass systems are turned to the locked or unlocked position from the inside and unlocked from the outside with a key.

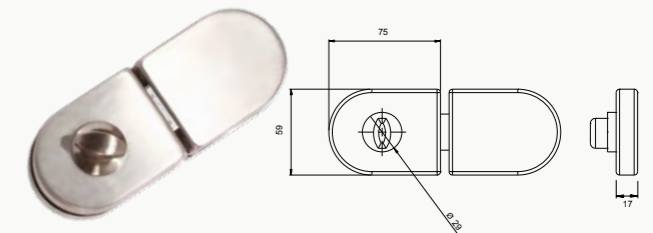

SLIDING GLASS MIDDLE LOCK

This beautiful security system for sliding glass is used on the middle rails of our sliding glass systems. All Metal Parts are made from Stainless Steel.

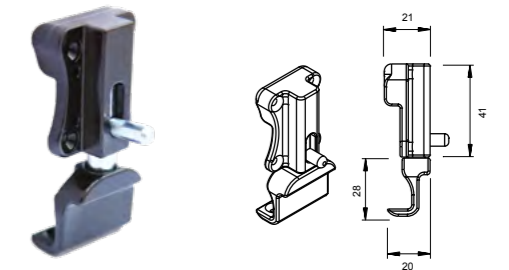

SLIDING GLASS INTERNAL LOCK

This attractive and functional locking system is used in Sliding Glass applications. It is installed on the internal side of the application and all metal parts are made from stainless steel. The bolt is designed to easily slip into the lock.

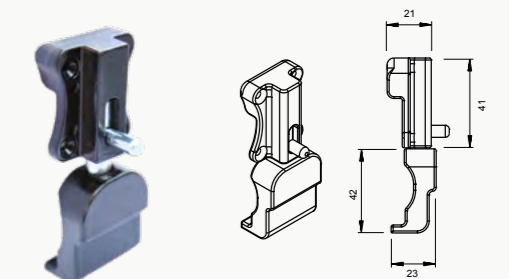

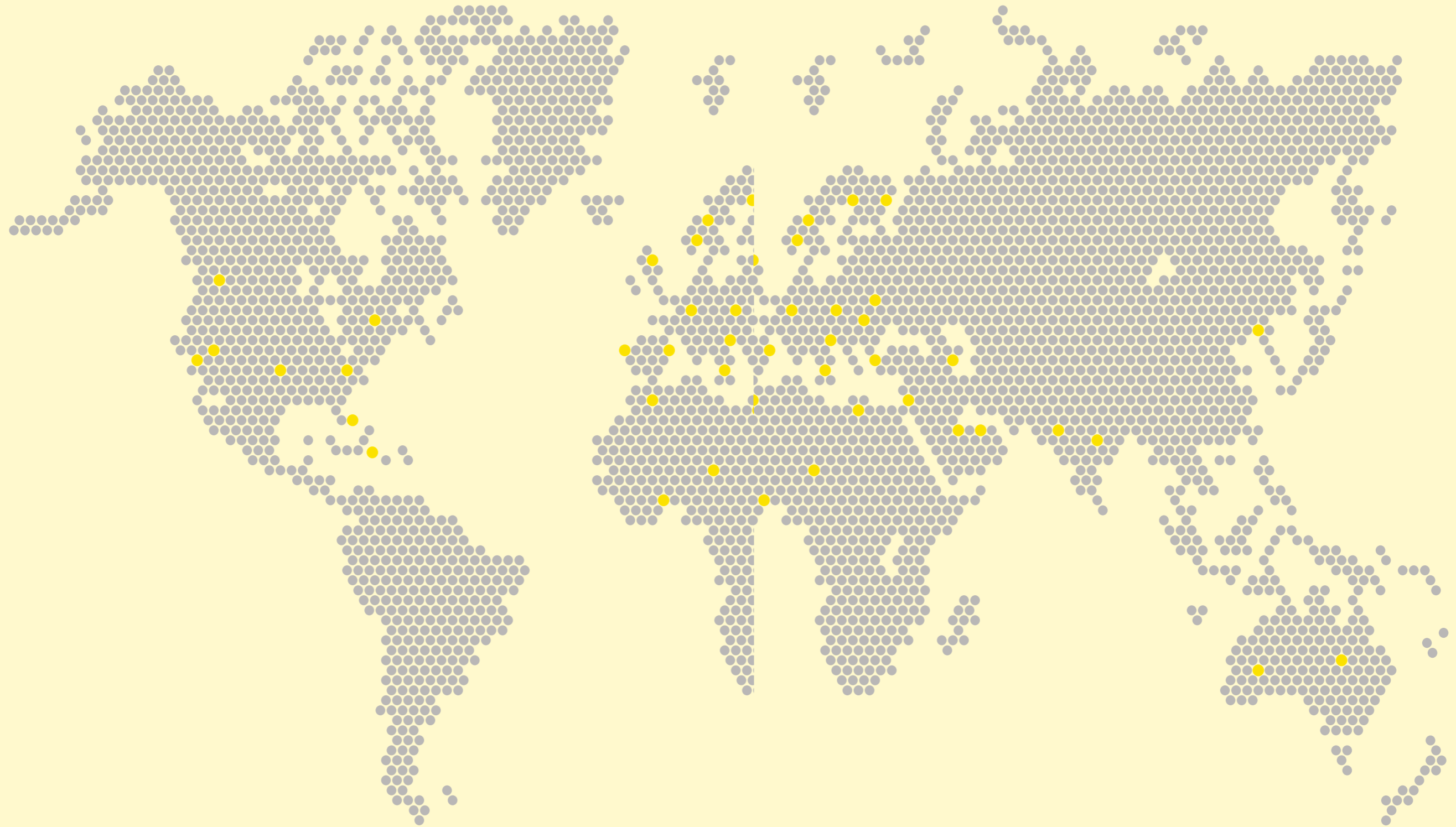

GLOBAL NETWORK

Palmiye is represented in many countries world wide and the values of each and every culture combined with unique architectural concepts, inspires and is reflected in Palmiye' s products.

HEAD OFFICE

World Trade Center IDTM A2 Blok No.77
Yeşilköy 34149 İstanbul – Türkiye
Phone: +90 212 886 7474
info@palmiyeglobal.com

FACTORY

Osmangazi Mah. 2647. Sok. No: 33/1
Esenyurt 34522 İstanbul
Phone: +90 212 886 32 44

